



ADLINK
TECHNOLOGY INC.

PXIS-2508/PXIS-2558T

3U 8-Slot Smart and Portable PXI Chassis
with Integrated LCD Touch Panel

User's Manual

Manual Rev. 2.01
Revision Date: August 24, 2007
Part No: 50-17026-2010



Recycled Paper

Advance Technologies; Automate the World.



Copyright 2007 ADLINK TECHNOLOGY INC.

All Rights Reserved.

Disclaimer

The information in this document is subject to change without prior notice in order to improve reliability, design, and function and does not represent a commitment on the part of the manufacturer.

In no event will the manufacturer be liable for direct, indirect, special, incidental, or consequential damages arising out of the use or inability to use the product or documentation, even if advised of the possibility of such damages.

This document contains proprietary information protected by copyright. All rights are reserved. No part of this manual may be reproduced by any mechanical, electronic, or other means in any form without prior written permission of the manufacturer.

Trademark Information

PXI is registered trademarks of PXI Systems Alliance. Other product names mentioned herein are used for identification purposes only and may be trademarks and/or registered trademarks of their respective companies.

Getting service

Customer satisfaction is our top priority. Contact us should you require any service or assistance.

ADLINK TECHNOLOGY INC.

Web Site	http://www.adlinktech.com
Sales & Service	service@adlinktech.com
Telephone No.	+886-2-8226-5877
Fax No.	+886-2-8226-5717
Mailing Address	9F No. 166 Jian Yi Road, Chungho City, Taipei Hsien 235, Taiwan, ROC

ADLINK TECHNOLOGY AMERICA, INC.

Sales & Service	info@adlinktech.com
Toll-Free	+1-866-4-ADLINK (235465)
Fax No.	+1-949-727-2099
Mailing Address	8900 Research Drive, Irvine, CA 92618, USA

ADLINK TECHNOLOGY EUROPEAN SALES OFFICE

Sales & Service	emea@adlinktech.com
Toll-Free	+49-211-4955552
Fax No.	+49-211-4955557
Mailing Address	Nord Carree 3, 40477 Düsseldorf, Germany

ADLINK TECHNOLOGY SINGAPORE PTE LTD.

Sales & Service	singapore@adlinktech.com
Telephone No.	+65-6844-2261
Fax No.	+65-6844-2263
Mailing Address	84 Genting Lane #07-02A, Cityneon Design Center, Singapore 349584

ADLINK TECHNOLOGY SINGAPORE PTE LTD. (INDIA Liaison Office)

Sales & Service	india@adlinktech.com
Telephone No.	+91-80-57605817
Fax No.	+91-80-26671806
Mailing Address	No. 1357, Ground Floor, "Anupama", Aurobindo Marg JP Nagar (Ph-1) Bangalore - 560078



ADLINK TECHNOLOGY INC. (KOREA Liaison Office)

Sales & Service korea@adlinktech.com
Telephone No. +82-2-20570565
Fax No. +82-2-20570563
Mailing Address 4F, Kostech Building, 262-2,
Yangjae-Dong, Seocho-Gu,
Seoul, 137-130, South Korea

ADLINK TECHNOLOGY (BEIJING) CO., LTD.

Sales & Service market@adlinkchina.com.cn
Telephone No. +86-10-5885-8666
Fax No. +86-10-5885-8625
Mailing Address Room 801, Building E, Yingchuangdongli
Plaza, No.1 Shangdidonglu,
Haidian District, Beijing, China

ADLINK TECHNOLOGY (SHANGHAI) CO., LTD.

Sales & Service market@adlinkchina.com.cn
Telephone No. +86-21-6495-5210
Fax No. +86-21-5450-0414
Mailing Address Floor 4, Bldg. 39, Caoheting Science and
Technology Park, No.333 Qinjiang Road,
Shanghai, China

ADLINK TECHNOLOGY (SHENZHEN) CO., LTD.

Sales & Service market@adlinkchina.com.cn
Telephone No. +86-755-2643-4858
Fax No. +86-755-2664-6353
Mailing Address C Block, 2nd Floor, Building A1,
Cyber-tech Zone, Gaoxin Ave. 7.S,
High-tech Industrial Park S.,
Nanshan District, Shenzhen,
Guangdong Province, China

Using this manual

Audience and scope

This manual guides you when using the portable ADLINK PXI chassis. This manual is intended for system integrators, computer programmers, and hardware engineers with advanced knowledge of PXI/cPCI systems and PXI-based data acquisition.

How this manual is organized

This manual is organized as follows:

Chapter 1 Introduction: This chapter introduces the PXIS-2508/2558T chassis including its features, specifications, and package contents.

Chapter 2 Chassis Overview: This chapter presents the chassis layout, location of basic components, dimensions, and backplane information.

Chapter 3 Installation: This part describes the procedures on how to install a system controller and peripheral modules into the PXIS-2508/2558T. It also contains information on OS and driver installations and touch panel usage.

Chapter 4 Remote Management: The chapter illustrates the remote management features of the PXIS-2508/2558T.

Appendix A: The Appendix comes with a troubleshooting section for common installation problems and tells you how to maintain the PXIS-2508/2558T chassis.

Important Safety Instructions: This section lists important safety reminders that you have to observe when using the chassis.

Warranty Policy: This presents the ADLINK Warranty Policy terms and coverages.

Conventions

Take note of the following conventions used throughout the manual to make sure that you perform certain tasks and instructions properly.

NOTE Additional information, aids, and tips that help you perform particular tasks.

IMPORTANT Critical information and instructions that you **MUST** perform to complete a task.

WARNING Information that prevents physical injury, data loss, module damage, program corruption etc. when trying to complete a particular task.

Table of Contents

List of Figures	iii
1 Introduction	1
1.1 Features.....	2
1.2 Specifications.....	3
1.3 Unpacking Checklist	5
2 Chassis Overview.....	7
2.1 Views	7
Front Panel	7
Rear Panel	9
Left Panel	10
Right Panel	11
Top Panel	12
Base Panel	13
2.2 Backplane Features.....	14
Inter-operability with CompactPCI	14
System Controller Slot	14
Star Trigger Slot	14
Peripheral Slots	15
Local Bus	15
Trigger Bus	16
System Reference Clock	16
3 Installation	17
3.1 Installing the System Controller	17
3.2 Installing Peripheral Modules.....	19
3.3 Cooling Considerations.....	21
3.4 Powering up the System.....	22
3.5 Installing the OS	24
3.6 Installing Device Drivers	24
Installing the Chassis Description File (chassis.ini)	24
Installing the VGA driver (PXIS-2558T only)	25
Installing the Touch Panel Driver (PXIS-2558T only) ...	26
Calibrating the Touch Panel	27
Using the Touch Panel (PXIS-2558T only)	29

4 Remote Management	31
4.1 Installing the Monitor Utility	32
4.2 Monitoring the System	33
Using the Monitor Utility (PXISRemoteMonUtil)	33
Using the Monitoring/Control Function Library	35
A Troubleshooting and Maintenance	43
A.1 Installation Problems.....	43
A.2 BIOS Beeps	43
A.3 Basic Troubleshooting	44
A.4 Maintenance	46
Taking Care of the Touch Panel LCD (PXIS-2558T only)	46
Changing the Fan Filter	46
Handling the Chassis	48
Handling Cables	48
Cleaning the Exterior	48
Power Requirements	48
Important Safety Instructions	49
Warranty Policy	51

List of Figures

Figure 2-1: PXIS-2508/2558T Front Panel	7
Figure 2-2: PXIS-2508/2558T Rear Panel.....	9
Figure 2-3: PXIS-2508/2558T Left Panel.....	10
Figure 2-4: PXIS-2508/2558T Right Panel	11
Figure 2-5: PXIS-2508/2558T Top Panel.....	12
Figure 2-6: PXIS-2508/2558T Base Panel.....	13
Figure 2-7: PXI Bus Signal Routing	15

1 Introduction

The ADLINK PXIS-2508/2558T is a highly portable 3U PXI chassis equipped with advanced features and functionalities that comply with PXI and CompactPCI specifications. Offering one system slot and seven peripheral slots, the PXIS-2508/2558T is set in a sleek and lightweight chassis for superior portability, wider operating temperature range, lower operating noise, and robust system build.

Equipped with an intelligent control board and sensors, the PXIS-2508/2558T dynamically monitors and manages the chassis status including the fan speed, system voltages, and internal temperature. Remote management is supported as the control board exports these sensor readings directly to a remote computer using the standard RS-232 port.

The PXIS-2558T is a derivative model with an integrated 8.4" LCD that supports an 800x600 resolution and touch panel capability. The integrated display allows you to carry the PXI-based testing equipment anytime and anywhere. Combined with the high-performance ADLINK PXI-3800 Series (PXIS-2558T-A) or PXI-3900 Series (PXIS-2558T-B) controller, the PXIS-2558T delivers a complete testing equipment that is suitable for a variety of applications.

These PXI chassis come with an industrial-grade 350 W AC power supply, front panel LEDs, and easy-access PXI/CompactPCI slots with card guides for convenient installation and use. With innovative features and robust design, the PXIS-2508 and PXIS-2558T are your best choices of PXI platform for all your test and measurement requirements.



PXIS-2508



PXIS-2558T

1.1 Features

- ▶ Compliant with PXI Specification Rev. 2.2
- ▶ Compact 8-slot PXI chassis with one system slot and seven PXI/CompactPCI peripheral slots
- ▶ 0°C to 55°C extended operating temperature range
- ▶ 41.6 dBA silent operation
- ▶ Intelligent chassis management
 - ▷ Automatic fan speed control
 - ▷ Round-the-clock chassis status monitoring
 - ▷ Remote chassis management including on/off control
- ▶ 5.9 kg lightweight aluminum-metal construction
- ▶ 8.4" built-in LCD with touch panel (PXIS-2558T only)
- ▶ 350 W industrial-grade AC power supply
- ▶ Power, temperature, and fan monitoring LEDs

1.2 Specifications

Power supply	
AC Input	
Input voltage range	100 V to 240 V
Input voltage frequency	50 to 60 Hz
Input current rating	8 A/115 V or 4 A/230 V
DC Output ¹	
Total DC power output	350 W
Integrated devices (PXIS-2558T only)	
Display	8.4" TFT LCD with 800x600 resolution
Input devices	Built-in touch panel
Cooling	
Fans	2 x 60 CFM fans with filters
Per slot cooling capacity	25 W (verified by 55°C chamber test)
Acoustic emissions	
Sound Pressure Level (dBA) <i>measure at operator position</i> ²	
Minimum fan speed	41.6 dBA
Maximum fan speed	47.3 dBA
Sound Power (dBA) ³	
Minimum fan speed	51.9 dBA
Maximum fan speed	55.5 dBA
Physical	
PXI slots	8 (1 system slot and 7 peripheral slots)
Dimension	280 mm x 177 mm x 303 mm (W x H x D)
Weight	
PXIS-2508	5.9 kg (13 lbs)
PXIS-2558T	6.4 kg (14 lbs)
Operating environment	
Ambient temperature	0°C to 55°C
Relative humidity	10% to 90%, non-condensing

Storage environment	
Ambient temperature	
PXIS-2508	-20°C to 70°C
PXIS-2558T	0°C to 70°C
Relative humidity	10% to 90%, non-condensing
Shock and vibration	
Functional shock	30 G half-sine, 11 ms pulse duration
Random vibration	
Operating	5 Hz to 500 Hz, 0.5 Grms, 3 axes
Non-operating	5 Hz to 500 Hz, 2.46 Grms, 3 axes
Certifications	
Safety	IEC 61010-1/EN 61010-1
Electromagnetic compatibility	
Emissions	EN 55011 Class A
Immunity	EN 61326-1
CE compliance	The PXIS-2508 and PXIS-2558T meet the essential requirements of applicable European Directives

¹ See DC Output Table below.

² Measured at operator position, tested in accordance with ISO 7779:1999/Amd.1:2003(E)

³ Tested in accordance with ISO 7779:1999/Amd.1:2003(E)

**Specifications are subject to change without notice.*

DC Output Table

VDC	Minimum	Maximum	Load Regulation	Max. Ripple & Noise
+5 V	3.0 A	35 A	±5%	50 mV
+12 V	2.0 A	18 A	±5%	120 mV
+3.3 V	1.0 A	20 A	±5%	50 mV
-12 V	0.1 A	2 A	±10%	150 mV

The combined output power of +5V and +3.3V shall not exceed 35A.

1.3 Unpacking Checklist

Before unpacking, check the shipping carton for any damage. If the shipping carton and/or contents are damaged, inform your dealer immediately. Retain the shipping carton and packing materials for inspection. Obtain authorization from your dealer before returning any product to ADLINK.

Check if the following items are included in the package.

Item	PXIS-2508	PXIS-2558T-A	PXIS-2558T-B
3U 8-slot PXI chassis with 350 W AC power supply and	○	X	X
3U 8-slot PXI chassis with 8.4" touch panel LCD and 350 W AC power supply	X	○	○
Power cords (110 V and 220 V)	○	○	○
Filler panel kit for unused/reserved slots including one 3-slot panel and seven 1-slot panels	○	○	○
Touch panel stylus with two holders	X	○	○
Two extra fan filters	○	○	○
ADLINK All-in-One CD	○	○	○
User's manual	○	○	○

NOTE OEM version package may vary depending on customer requests. The assigned controller and/or peripheral modules may be pre-installed and shipped with the chassis. Inquire with your dealer for additional information on these options.

2 Chassis Overview

This section describes the PXIS-2508/2558T chassis including the location of basic components and control, dimensions, and back-plane features.

2.1 Views

Front Panel

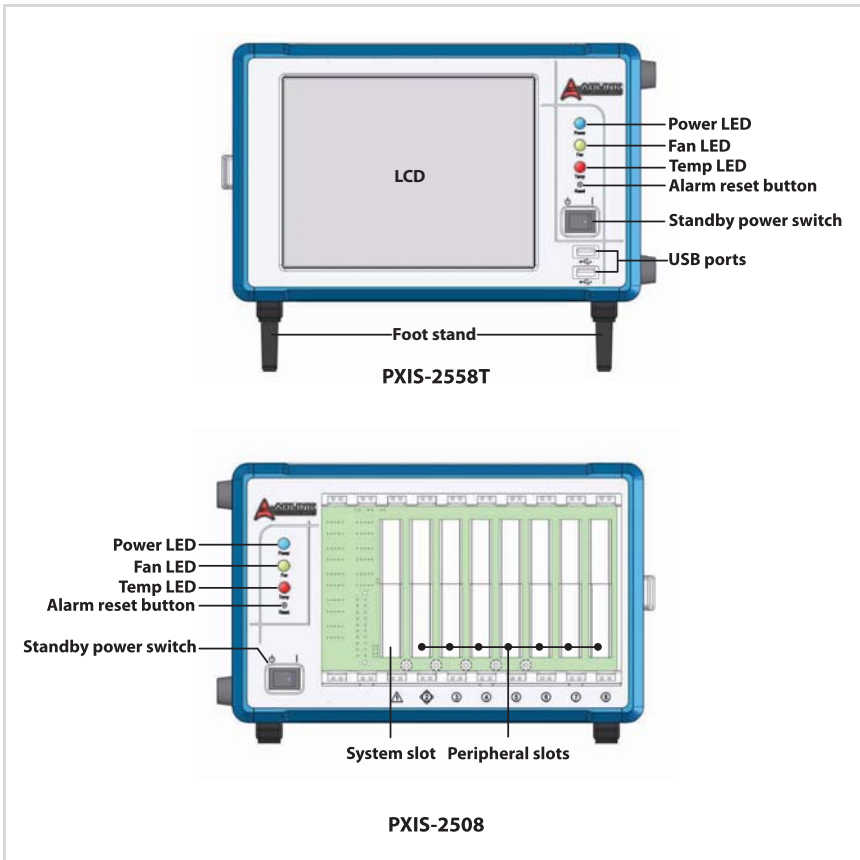

Figure 2-1: PXIS-2508/2558T Front Panel

LED Indications

LED	Status		
	On	Off	Blinking
Power (Blue)	DC voltages are supplied normally.	No DC power is supplied.	<ul style="list-style-type: none"> • 5 V or 3.3 V exceeds $\pm 7\%$ range • 12 V or -12 V exceeds $\pm 12\%$ range
Fan (Green)	Fans are operating normally.	The system is off.	Any of the fans is operating in a speed lower than 500 RPM
Temp (Amber)	Chassis temperature is normal	The system is off.	Chassis temperature exceeds 50°C

Alarm Reset Button

The alarm reset button enables you to stop the chassis alarm during an error or critical system event. To stop the alarm, press the alarm reset button.

Rear Panel

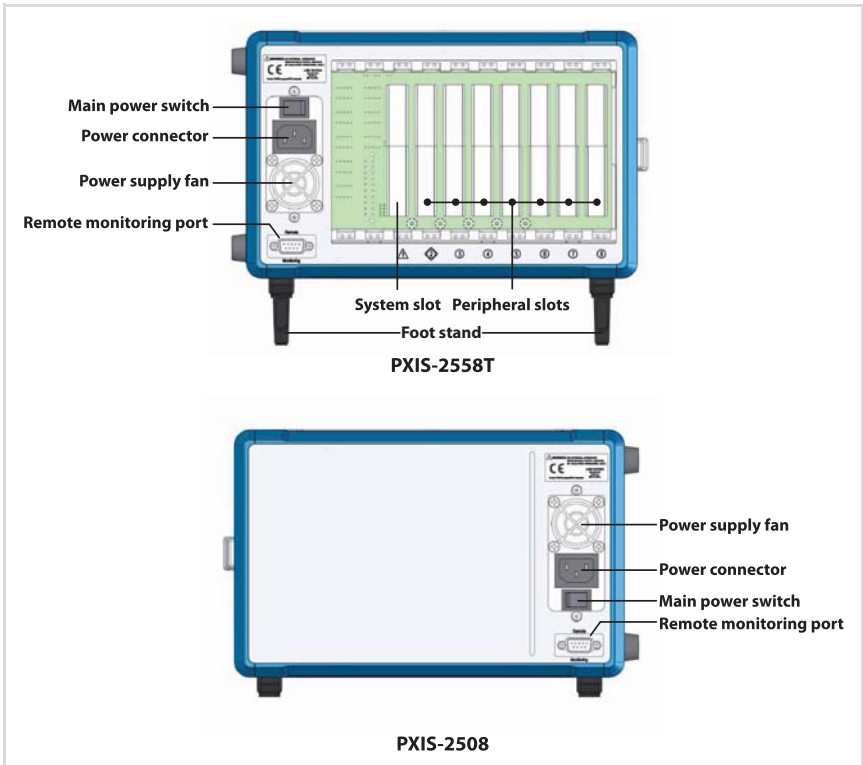

Figure 2-2: PXIS-2508/2558T Rear Panel

Left Panel

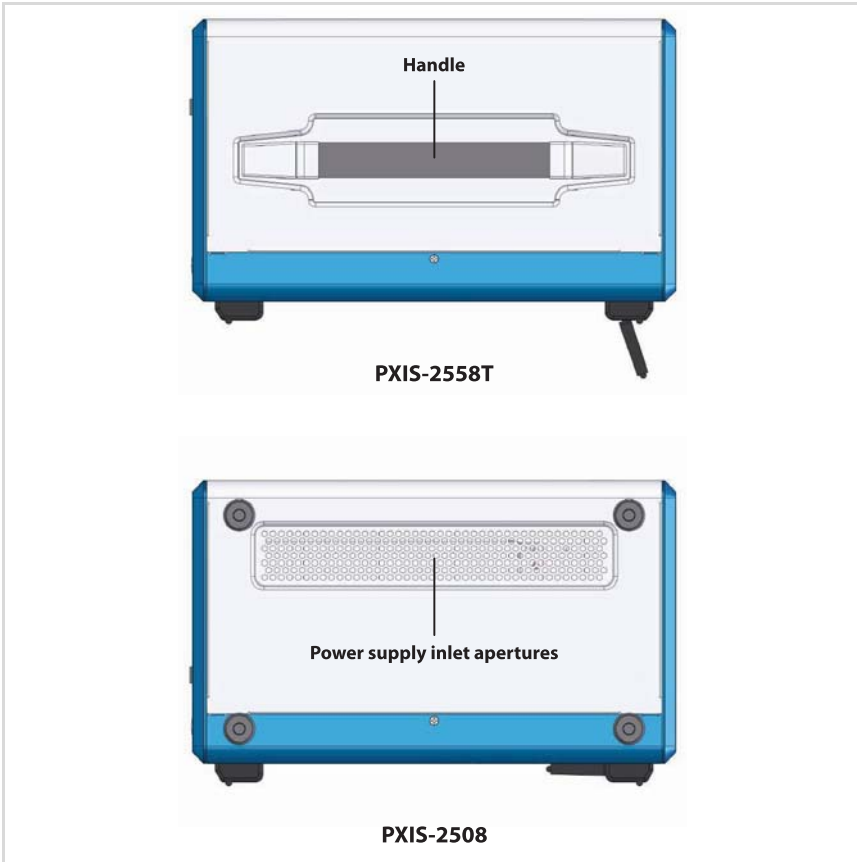

Figure 2-3: PXIS-2508/2558T Left Panel

Right Panel

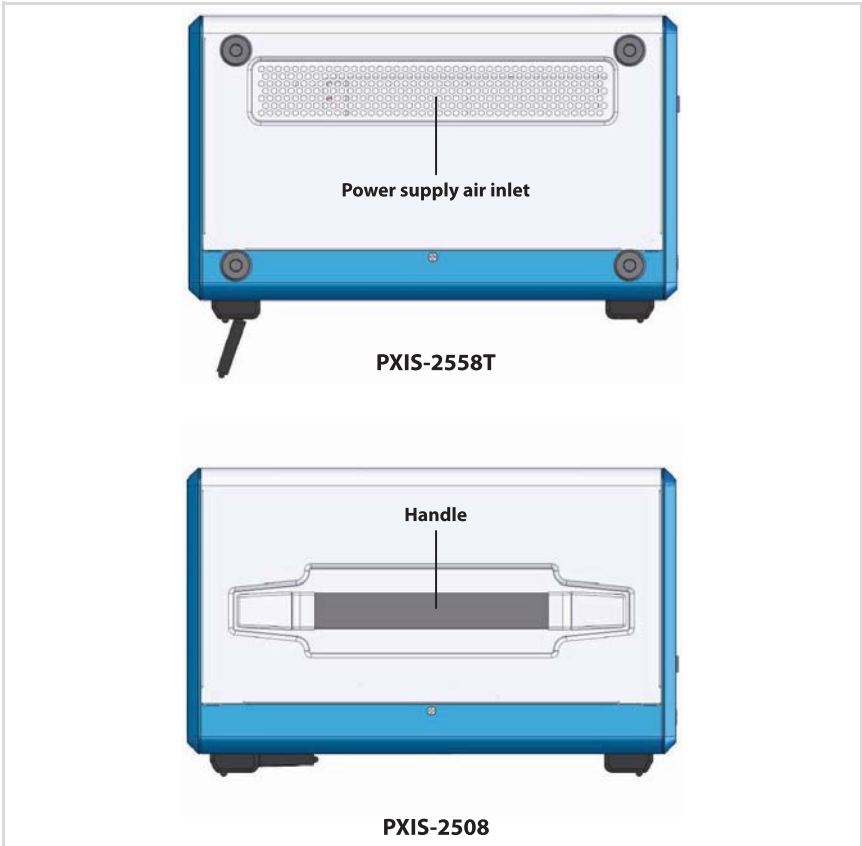

Figure 2-4: PXIS-2508/2558T Right Panel

Top Panel

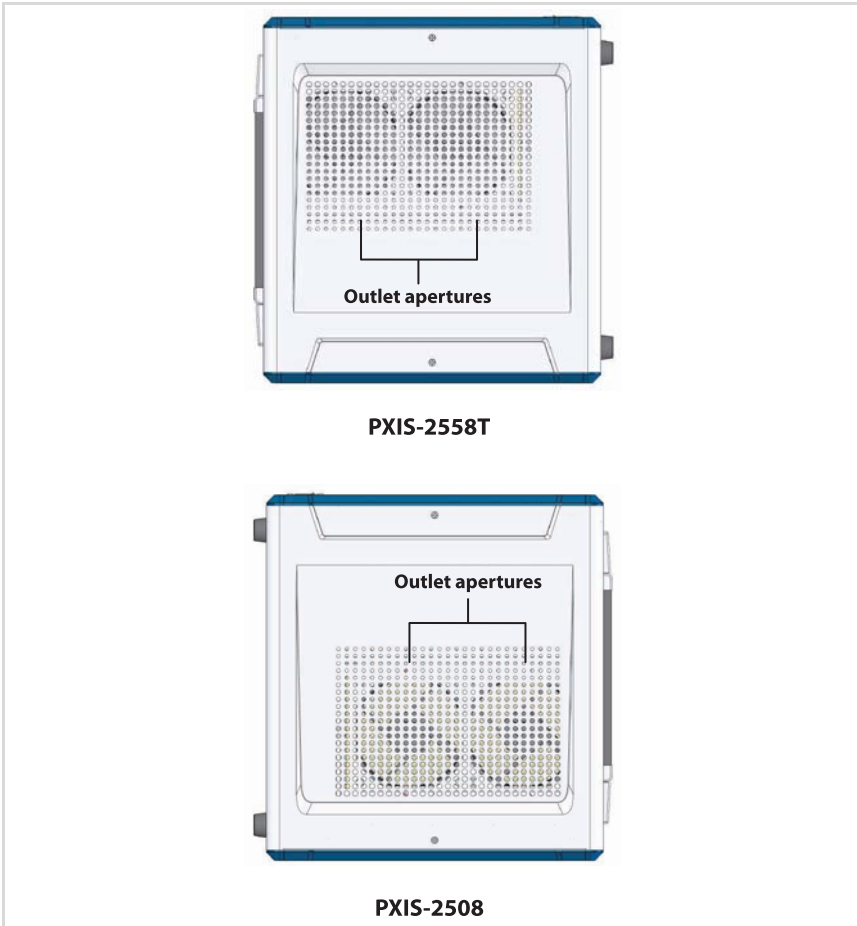

Figure 2-5: PXIS-2508/2558T Top Panel

Base Panel

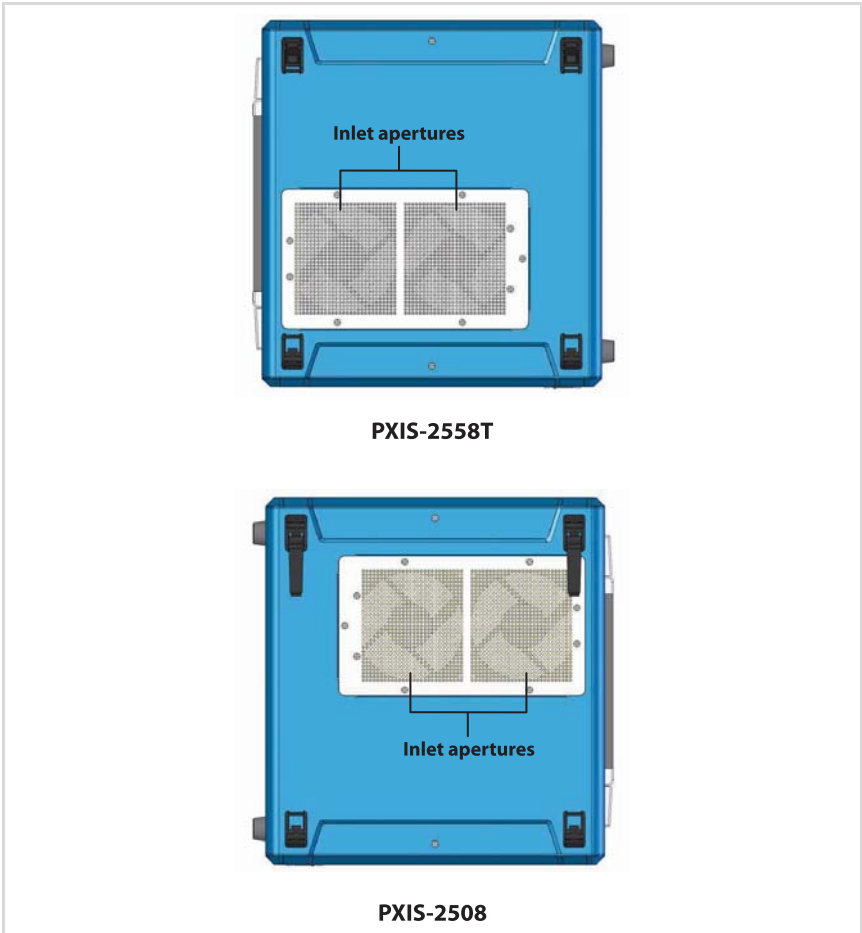

Figure 2-6: PXIS-2508/2558T Base Panel

2.2 Backplane Features

Inter-operability with CompactPCI

With backplanes that are compliant with PXI Specification Rev. 2.2, the PXIS-2508 and PXIS-2558T are designed to support both standard PXI and CompactPCI modules.

The signals on the backplane's P1 connector meet the requirements of CompactPCI specifications for both peripheral and system modules. The PXI-specific signals located on P2 are reserved or unused in CompactPCI 64-bit specifications. This allows peripheral modules with CompactPCI 64-bit specifications to function in both PXIS-2508 and PXIS-2558T.

NOTE CompactPCI peripheral modules which operate with rear I/O modules may not work in PXIS-2508/2558T due to the conflict between rear I/O signals and PXI-specific signals on J2.

System Controller Slot

Slot 1 is designated as the system controller slot as defined by PXI specifications. The PXIS-2508/PXIS-2558T can accommodate a PXI system controller with up to 3-slot width. As defined in PXI specifications, the system controller slot allows the controller to expand to the left to prevent it from occupying the peripheral slot space.

Star Trigger Slot

Slot 2 is designated as the star trigger (ST) slot. This slot comes with dedicated trigger lines between itself and peripheral slots 3 to 8. The star trigger functionality is intended to provide precise trigger signals to the peripheral modules by installing a specific star trigger controller modules in the ST slot. The star trigger slot can be also used as a general peripheral slot if you will not use the star trigger functionality.

Peripheral Slots

The PXIS-2508/2558T comes with seven peripheral slots including the star trigger slot. Each peripheral slot supports a 3U PXI/CompactPCI peripheral module.

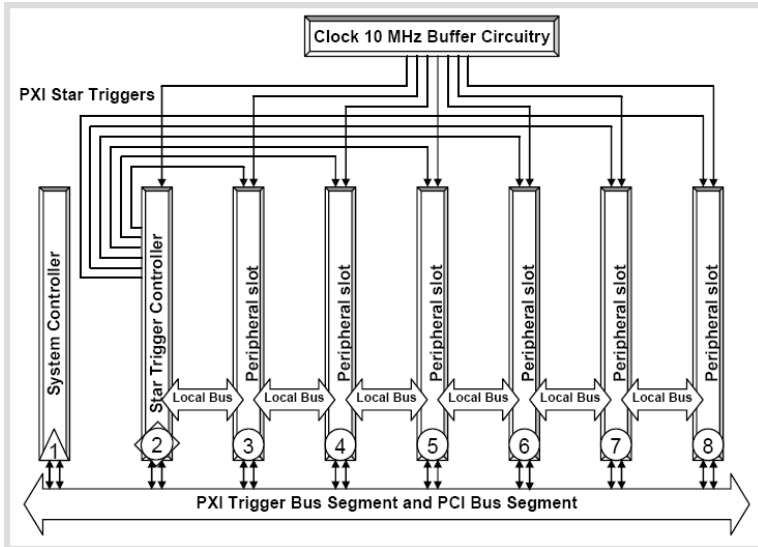

Figure 2-7: PXI Bus Signal Routing

Local Bus

The PXI backplane local bus is a daisy-chained bus that connects each peripheral slot with its adjacent (left/right) peripheral slots. Each local bus has 13 lines and can transmit analog or digital signals between modules. It also provides a high-speed side-band communication path that does not affect the PXI bandwidth.

Based on PXI specifications, the local bus connects all adjacent slots except slots 1 and 2.

Trigger Bus

The trigger bus is an 8-line bus that connects all PXI slots in the same PCI segment. You can use the trigger bus as an intermodule synchronization mechanism. PXI modules can transmit trigger or clock signals to one another through the trigger bus, enabling precise timed responses to asynchronous external events that the system is monitoring or controlling.

System Reference Clock

The backplane comes with a PXI 10 MHz system reference clock (PXI_CLK10). An independent buffer (having source impedance matched to the backplane and a skew of less than 1 ns between slots) drives the clock signal generated from a high-precision oscillator to each peripheral slot. You can use this common reference clock signal to synchronize multiple modules in a PXI chassis.

3 Installation

The chapter tells you how to install the system controller, peripheral modules, and drivers to the PXIS-2508/2558T chassis. It also provides information on cooling considerations, and installation/calibration of the touch panel (PXIS-2558T only)

3.1 Installing the System Controller

The PXIS-2508/2558T comes with a system controller slot that supports a PXI system controller. We recommend the following system controllers for use with the PXIS-2558T:

- ▶ PXI-3800 Series for PXIS-2558T-A model
- ▶ PXI-3900 Series for PXIS-2558T-B model

To install the system controller:

1. Make sure that the CPU, memory module(s), and storage device(s) are properly installed on the system controller module.
2. Locate the system controller slot (Slot 1).



3. Push down (loose) the system controller module's ejector/injector handle(s).

4. Align the module's top and bottom edges to the card guides, then carefully slide the module into the chassis,



5. Pull up the ejector/injector handle(s) until the module is properly connected to the chassis backplane.



6. Fasten the screws on the module front panel, then connect all devices to the system controller.



3.2 Installing Peripheral Modules

The PXIS-2508/2558T supports up to seven PXI/cPCI peripheral modules, including a star trigger module.

To install a peripheral module:

1. Select an available peripheral slot (slots 2 to 8).
2. Push down (loose) the peripheral module's ejector/injector handle(s), then align the module's top and bottom edges to the card guides.
3. Carefully slide the module into the chassis..



4. Pull up the ejector/injector handle until the module is properly connected to the chassis backplane.



5. Fasten the screw on the module front panel, then connect all devices.



3.3 Cooling Considerations

The PXIS-2508/2558T implements a forced air-cooling mechanism to maintain a stable chassis and power supply temperature. Room/cold air is taken in by internal chassis fans from the air inlet apertures at the bottom of the chassis while hot air is exhausted through the air outlet apertures on top. Refer to the illustration below.

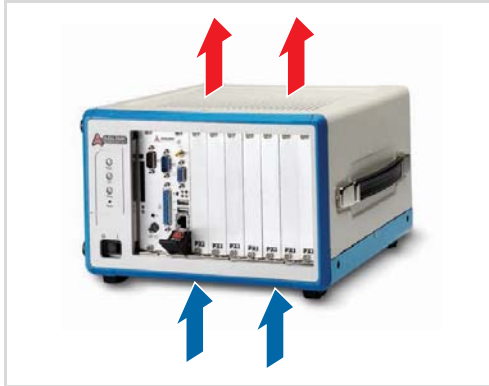

For bench top installations, provide adequate clearance for the air inlet and outlet apertures. Keep other objects or equipment at least 5 cm (2 in) away from the outlet apertures and avoid covering these holes. For optimum airflow, provide ample clearance for the air inlet apertures and open the foot stands, if possible.

There are also air inlet apertures on one side of the chassis for power supply ventilation. Hot air from the power supply is exhausted through the chassis rear. Maintain a 2.5 cm (1 in) clearance on the chassis sides for adequate power supply ventilation.



3.4 Powering up the System

The PXIS-2508/2558T is equipped with a universal power supply unit that does not require input voltage selection.

To turn on the system:

1. Connect one end of the supplied power cable to the power connector located at the rear side of the chassis.

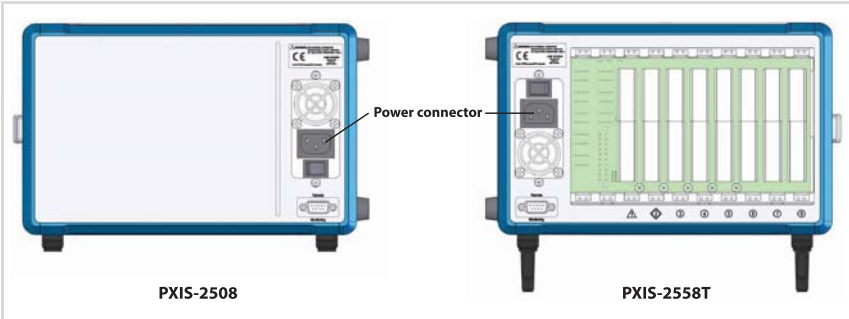

2. Plug the other end of the AC power cord to a properly grounded wall socket or power strip.
3. Turn on the main power switch (I).

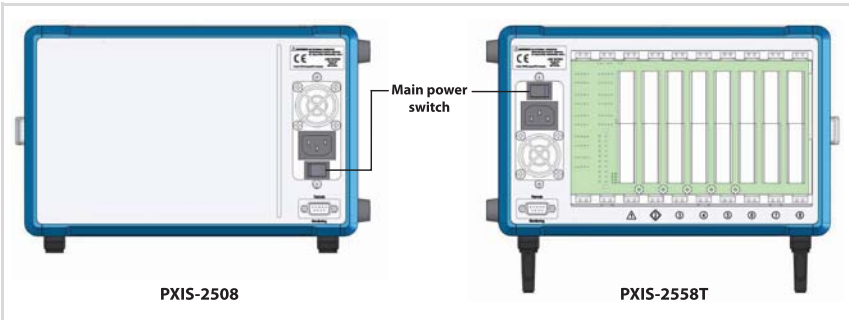

4. Turn on the standby power switch at the front panel. The power LED in the front panel lights up green and the chassis fans start to operate.

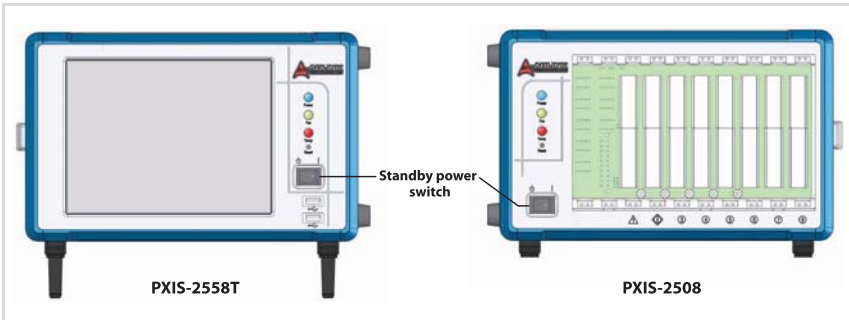

To turn off the system:

1. Shut down the system via the operating system.
2. Move the standby power switch to standby position (⏻)

OR

3. Turn off the main power switch (O).

IMPORTANT When you put the system into standby mode using the standby power switch, wait three seconds before you turn on the system again. This protects installed PXI modules from damage.

If you turn on the system immediately from standby-by mode, it may take at least three seconds for the POST messages to appear on screen.

3.5 Installing the OS

Install the operating system that your system controller supports. For more information, refer to the documentation provided by the operating system vendor and the system controller manual.

Most operating systems requires installation from a floppy or optical disk drive. These devices must be configured, installed, and tested with the supplied drivers before attempting to install a new operating system.

Consult the release notes and installation documentation provided by the operating system vendor for documentation discrepancies and/or compatibility issues, problems, and solutions.

3.6 Installing Device Drivers

Installing the Chassis Description File (chassis.ini)

To allow inter-operability of PXI platform and modules from different vendors, PXI specifications define the hardware description files to describe the hardware characteristics in ASCII text format. System integrators can use the hardware description files to configure the system with various PXI controller, PXI chassis, and PXI modules.

ADLINK provides a complete list of the chassis description files (chassis.ini) for the PXI chassis. You can find the chassis description files in X:\Driver Installation\PXI Platform\PXI Platform Description\ (X: is the CD-ROM drive where you placed the ADLINK All-in-One CD). A simple how to document is also existed in the directory to illustrate the procedures of using the chassis description file with third-party software to build up your PXI system.

Installing the VGA driver (PXIS-2558T only)

The PXIS-2558T is equipped with a 8.4" LCD with touch panel feature. You must install the correct drivers for the LCD and the touch panel to function.

There are two PXIS-2558T chassis derivatives: PXIS-2558T-A for use with an ADLINK PXI-3800 Series controller and PXIS-2558T-B for use with an ADLINK PXI-3900 Series controller. Make sure to install the correct drivers according to the installed controllers. You may find the VGA drivers in the ADLINK All-in-One CD. Refer to the list below:

- ▶ For PXIS-2558T-A with a PXI-3800 controller, the VGA driver is located in this folder:

```
X:\Driver Installation\PXI Platform\PXI  
controller\PXI-3800\VGA\
```

- ▶ For PXIS-2558T-B with a PXI-3910 or PXI-3920 controller, the VGA driver is located in this folder:

```
X:\Driver Installation\PXI Platform\PXI  
controller\PXI-3910_20\VGA\
```

- ▶ For PXIS-2558T-B with a PXI-3950 controller, the VGA driver is located in this folder:

```
X:\Driver Installation\PXI Platform\PXI  
controller\PXI-3950\VGA\
```

To install the VGA driver:

1. Connect an external monitor to the VGA port of the PXI controller.
2. Adjust the PXI controller BIOS Setup to output the video signals using the rear panel I/O. Refer to the PXI controller documentation for details.
3. Install the correct VGA driver according to the PXI controller. Refer to the list above.
4. If the VGA driver supports dual-display mode, make sure the video signal is output to both display devices (monitor and notebook). Refer to the PXI controller documentation for details.

Installing the Touch Panel Driver (PXIS-2558T only)

The PXIS-2558T LCD is equipped with touch panel functionality for convenient data input and GUI navigation.

To install the touch panel driver:

1. Connect a USB CD-/DVD-ROM to the system or PXI controller.
2. Place the ADLINK All-in-Once CD in the optical drive.
3. Locate the touch panel drivers in:

```
X:\Driver Installation\PXI Platform\PXI  
chassis\PXIS-2508_2558T\Touch Panel\
```

then double-click on the Setup.exe file to begin installation.

4. After installation is finished, a calibration program appears. Refer to the next section for details.

Calibrating the Touch Panel

After installing the touch panel driver, you need to calibrate the screen for accurate touch operation. The calibration tool (XTouchWare) is automatically installed together with the touch panel driver.

To calibrate the touch panel:

1. Tap or double-click on the XTouchWare icon from the desktop or launch the utility from the Windows Start menu.
2. Tap or click on the **Calibration** button. A 4-point calibration window appears.

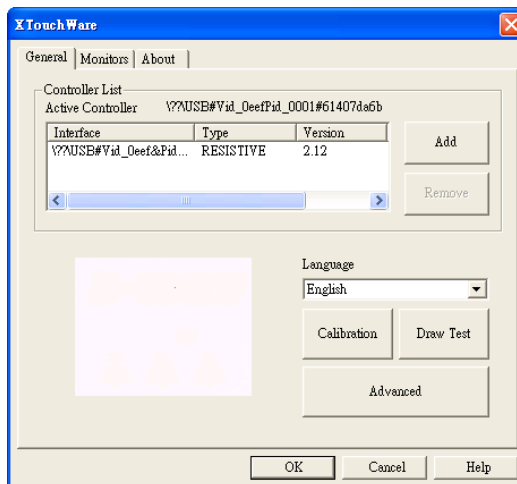

3. Tap or click on the intersection of the blinking **X** symbol, then hold for a few seconds until it stops blinking. Repeat the process for all X symbols that will appear on four corners of the screen.

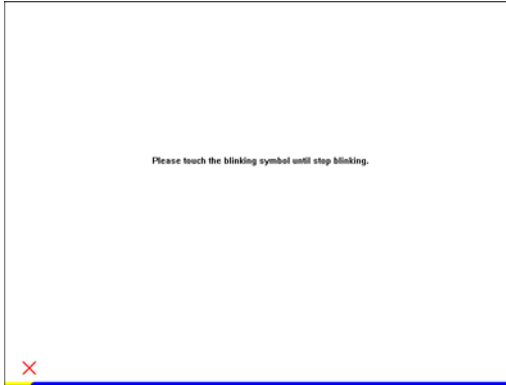

4. When finished, click **OK** to store the calibration data.

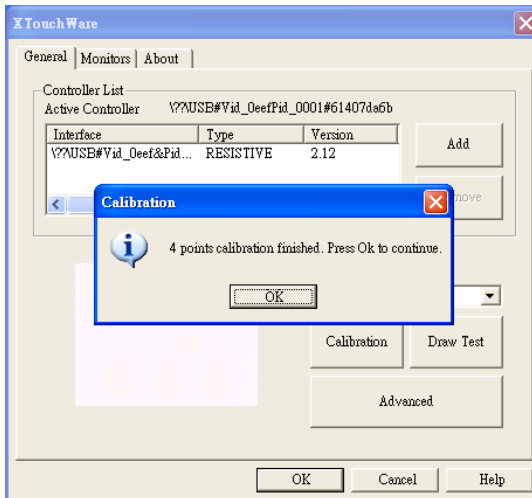

Using the Touch Panel (PXIS-2558T only)

The PXIS-2558T touch panel LCD provides an intuitive way to interact with the operating system. You can use the touch panel as a replacement for a mouse. Use the supplied touch panel stylus or your finger to move the cursor onscreen. The table below lists all mouse operations and their corresponding touch panel equivalents.

Mouse operation	Touch panel
Left-click	Tap the screen once
Right-click	Tap and hold the screen for 3 to 5 seconds
Double-click	Tap the screen twice
Drag and drop	Tap the screen, then drag the window by moving the stylus or your finger

4 Remote Management

The PXIS-2508 and PXIS-2558T chassis provide an advanced remote monitoring and control functions. The chassis status, including its internal temperature, fan speed, and DC voltages, are exported via the standard RS-232 port located in the rear panel allowing you to monitor the system on a remote computer. You may also use a remote computer to turn the system on or off through the monitoring port by sending software commands.



To remotely monitor and control the PXIS-2508/2558T, you need to connect the remote monitoring port to a remote computer using a standard RS-232 cable.

4.1 Installing the Monitor Utility

You can find a setup file to install the remote monitoring utility and function library in ADLINK All-in-One CD.

To install the monitoring utility:

1. Connect a USB CD-/DVD-ROM to the system controller.
2. Place the ADLINK All-in-Once CD in the optical drive.
3. Locate the monitoring utility in this folder:

```
X:\Driver Installation\PXI Platform\PXI  
chassis\PXIS-2508_2558T\RemoteMon\
```

then double-click on the Setup.exe file to begin installation.

4.2 Monitoring the System

Using the Monitor Utility (PXISRemoteMonUtil)

To monitor the system using the monitor utility:

1. Launch the PXISRemoteMonUtil.
2. Select the COM port that connects the remote computer with the PXIS-2508/2558T (COM5 in this example).

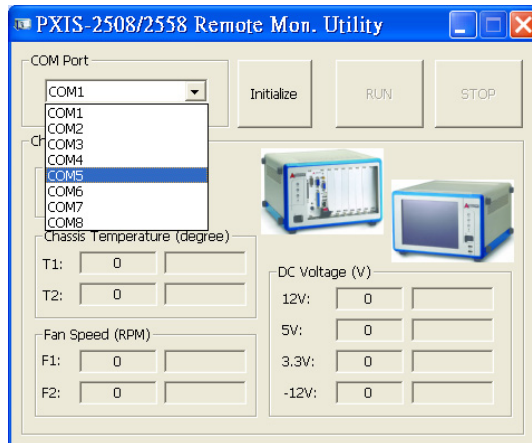

- Click **Initialize** to initialize the COM port. If the COM port is successfully initialized, the **RUN** button is enabled.

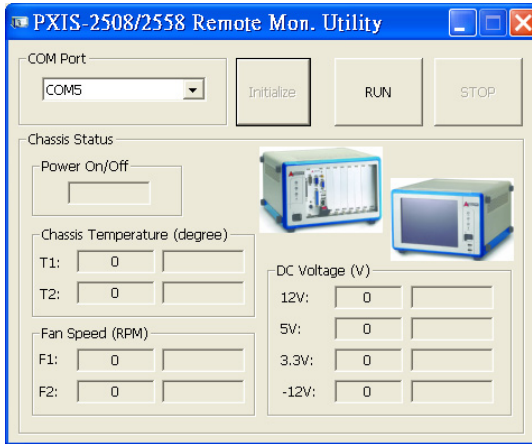

- Click the **RUN** to display the chassis temperature, fans' speed, and DC voltages. These values automatically update.

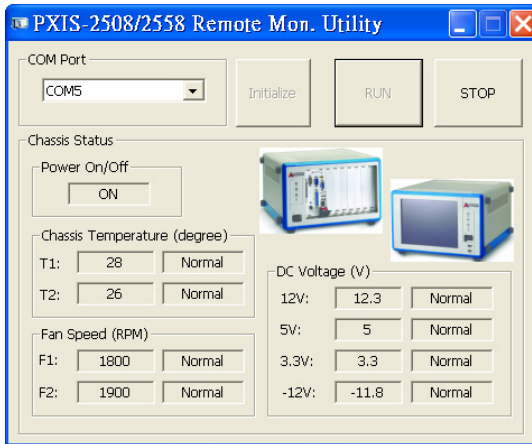

- Click **STOP** to stop monitoring.

Using the Monitoring/Control Function Library

You can use the monitoring/control function library to create a customized program that would monitor and control the PXIS-2508/2558T. Refer to the data structure and function library below.

Data Structure

In the library, a data structure is defined to describe the chassis status.

```
typedef struct tagChassisStatus
{
    BYTE          PowerStatus

    //Fan status and RPM
    BYTE          Fan1Status;
    BYTE          Fan2Status;
    BYTE          Fan3Status;
    BYTE          Fan4Status;
    BYTE          Fan5Status;
    BYTE          Fan6Status;
    float         Fan1RPM;
    float         Fan2RPM;
    float         Fan3RPM;
    float         Fan4RPM;
    float         Fan5RPM;
    float         Fan6RPM;

    //Temperature sensor status and reading in
    degree centigrade
    BYTE          Temp1Status;
    BYTE          Temp2Status;
    float         Temp1Reading;
    float         Temp2Reading;

    //DC status and reading
    BYTE          DC1Status;
    BYTE          DC2Status;
    BYTE          DC3Status;
    BYTE          DC4Status;
    float         DC1Reading;
    float         DC2Reading;
    float         DC3Reading;
    float         DC4Reading;
```

```

    BYTE    Reserve1;
    BYTE    Reserve2;
} ChassisStatus;

```

The variables in the data structure are illustrated below.

Variable	Description	Type	Value
PowerStatus	Power On/Off status	BYTE	0: Off 1: On
Fan1Status	Fan#1 operating status	BYTE	0: Normal 1: Abnormal
Fan2Status	Fan#2 operating status	BYTE	0: Normal 1: Abnormal
Fan3Status	Not used for PXIS-2508/2558T	BYTE	N/A
Fan4Status	Not used for PXIS-2508/2558T	BYTE	N/A
Fan5Status	Not used for PXIS-2508/2558T	BYTE	N/A
Fan6Status	Not used for PXIS-2508/2558T	BYTE	N/A
Fan1RPM	Fan#1 speed in RPM	float	RPM value
Fan2RPM	Fan#2 speed in RPM	float	RPM value
Fan3RPM	Not used for PXIS-2508/2558T	float	N/A
Fan4RPM	Not used for PXIS-2508/2558T	float	N/A
Fan5RPM	Not used for PXIS-2508/2558T	float	N/A
Fan5RPM	Not used for PXIS-2508/2558T	float	N/A
Temp1Status	Temperature sensor#1 status	BYTE	0: Normal 1: Abnormal
Temp2Status	Temperature sensor#1 status	BYTE	0: Normal 1: Abnormal
Temp1Reading	Reading of temperature sensor#1 in °C	float	Temperature value
Temp1Reading	Reading of temperature sensor#2 in °C	float	Temperature value
DC1Status	DC 12V status	BYTE	0: Normal 1: Abnormal
DC2Status	DC 5V status	BYTE	0: Normal 1: Abnormal
DC3Status	DC 3.3V status	BYTE	0: Normal 1: Abnormal
DC4Status	DC -12V status	BYTE	0: Normal 1: Abnormal
DC1Reading	DC 12V voltage reading	float	Voltage value
DC2Reading	DC 5V voltage reading	float	Voltage value
DC3Reading	DC 3.3V voltage reading	float	Voltage value

Variable	Description	Type	Value
DC4Reading	DC -12V voltage reading	float	Voltage value

Function Reference

InitCOM

Description

Initializes the remote computer COM port connected to the remote monitoring port of the PXIS-2508/2558T.

Syntax

```
HANDLE InitCOM(LPCSTR com)
```

Parameter

com A string denotes the COM port. Can be COM1 ~ COM8.

Return Value

A handle to the initialized COM port. If the function returns NULL, the initialization of COM port failed.

Example

```
HANDLE hCOM;
hCOM= InitCOM("COM1");
```

GetChassisStatus

Description

Gets the chassis status and stores the status in a ChassisStatus structure. You can invoke this function periodically to update the chassis status.

Syntax

```
BOOL GetChassisStatus(HANDLE hCom, ChassisStatus*  
    Status)
```

Parameters

hCom The initialized COM port.

Status ChassisStatus data structure that stores the chassis status

Return Value

TRUE if the function succeeded. FALSE if the function failed.

Example

```
ChassisStatus    status;  
BOOL            ret;  
ret= GetChassisStatus(hCom, &status);
```

SetChassisPowerOn

Description

Powers on the PXIS-2508/2558T.

Syntax

```
BOOL SetChassisPowerOn (HANDLE hCom)
```

Parameter

com The initialized COM port.

Return Value

TRUE if the function succeeded. FALSE if the function failed.

Example

```
BOOL                    ret;  
ret= SetChassisPowerOn (hCom);
```

SetChassisPowerOff

Description

Powers off the PXIS-2508/2558T. You should shut down the system controller via the operating system before turning off the chassis power.

Syntax

```
BOOL SetChassisPowerOff (HANDLE hCom)
```

Parameter

com The initialized COM port.

Return Value

TRUE if the function succeeded. FALSE if the function failed.

Example

```
BOOL                    ret;  
ret= SetChassisPowerOff (hCom);
```

CloseCOM

Description

Closes the initialized COM port.

Syntax

```
BOOL CloseCOM(HANDLE hCom)
```

Parameter

com The initialized COM port.

Return Value

TRUE if the function succeeded. FALSE if the function failed.

Example

```
BOOL                    ret;  
ret= CloseCOM (hCom);
```

Appendix A Troubleshooting and Maintenance

A.1 Installation Problems

Failure to start the system usually results from incorrect installation of the system controller, peripheral modules, and other components. Go through the following checklist before you start up the system.

- ▶ The system controller is properly installed and secured.
- ▶ All peripheral modules are properly seated on the slots.
- ▶ All cables are properly connected to the system controller/peripheral modules.
- ▶ All peripheral modules installed are compatible for use in the chassis.
- ▶ The power cord is properly plugged into the chassis power connector and power outlet/wall socket/power strip.

If the system fails to turn on even after all installation conditions are met, remove all peripheral modules that you installed, then try again. If the system turns on properly, try installing one peripheral module at a time, then test if the system will power-up. You may also try installing the modules into different slots until you get the desired result.

A.2 BIOS Beeps

BIOS beeps indicate errors in system initialization. These beeps are usually associated with video and memory errors. If the system beeps during start up, check if the display is properly connected to the system controller or if the integrated LCD drivers (PXIS-2558T only) are properly installed. You may also check if the memory modules are properly installed in the system controller.

A.3 Basic Troubleshooting

Problem	What to Do
System fails to power up	<ul style="list-style-type: none"> ▶ Check if the power cord is properly plugged into the chassis power connector and wall socket/power strip. ▶ Check if the wall socket/power strip is live. ▶ Check if the main power switch at the back of the chassis is turned on. ▶ Make sure the standby power button at the chassis front panel is turned on.
There is no LCD display (PXIS-2558T only)	<ul style="list-style-type: none"> ▶ Make sure the system is turned on. ▶ Connect an external display to the system controller's VGA port, then check if there is video output. ▶ If video output is present on the external display, adjust your display settings and enable LCD video. ▶ If video output is not present on the external display, check if the system controller is properly installed. ▶ If there is no video output even when the system controller is properly installed, contact ADLINK for further assistance.
There is no video output in the external display	<ul style="list-style-type: none"> ▶ Redirect the video output to the integrated LCD (PXIS-2558T only). ▶ Check if your external display is functioning. ▶ Check your display settings and make sure you enable external video.

Problem	What to Do
The touch panel doesn't work	<ul style="list-style-type: none"><li data-bbox="490 209 949 300">▶ Disconnect an external PS/2 or USB mouse cable from the system controller, if any.<li data-bbox="490 312 934 370">▶ Make sure you installed the touch panel drivers.
The touch panel is not responsive enough or is very sensitive to stylus and/or finger tap.	<ul style="list-style-type: none"><li data-bbox="490 387 922 445">▶ Run the XTouchware utility to recalibrate the touch panel.<li data-bbox="490 458 930 483">▶ Clean the LCD with a clean cloth.

A.4 Maintenance

Taking Care of the Touch Panel LCD (PXIS-2558T only)

Clean the LCD periodically with a moist cloth for better display. Observe the following precautions when cleaning the LCD.

- ▶ Do not use any abrasive material to wipe the LCD screen to avoid scratching the LCD surface.
- ▶ Do not apply too much pressure on the surface when wiping the LCD screen.
- ▶ Do not use a cleaner that contains alcohol.
- ▶ Do not use a rough cloth that could scratch the LCD screen surface.
- ▶ Clean the LCD screen with gentle wipes in one direction.

Changing the Fan Filter

The air inlet fans installed at the bottom of the chassis comes with a filter to prevent dirt and dust from entering the chassis. You need to periodically replace the air filter to maintain good chassis air-flow.

To change the fan filter:

1. Turn off the chassis, then disconnect all cables connected to the chassis, system controller, and peripheral modules.
2. Lay the chassis upside down in a flat and stable surface.
3. Loosen five screws, lift the fan tray carefully, then lay it on top of the chassis.

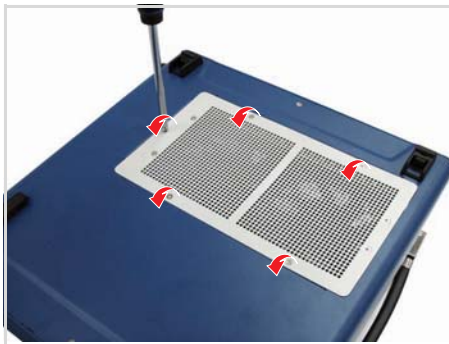

4. Loosen four screws to remove the fan tray cover.

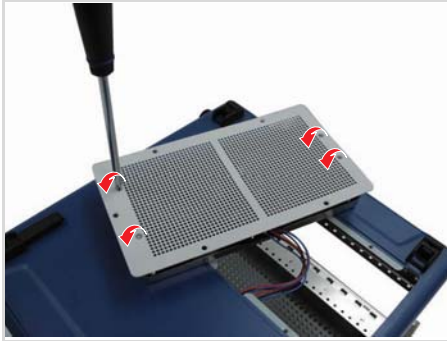

5. Take off the old air filter.

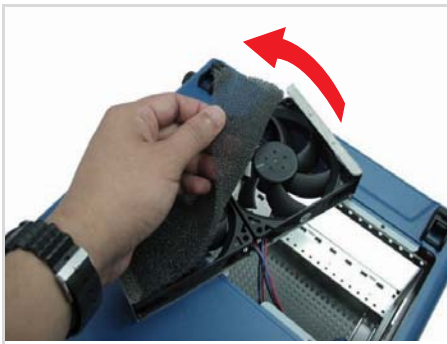

6. Peel the adhesive on both ends of the new air filter, then stick them on the fan tray edges. Stretch the filter to cover the whole fan tray length.

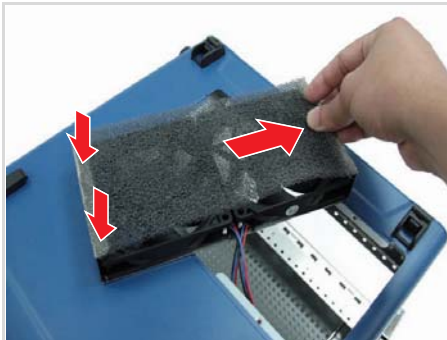

WARNING Make sure the fan blades do not come in contact with the air filter.

7. Replace the fan tray cover, then re-install the fan tray to the chassis.
8. Connect all cables, then turn on the system.

Handling the Chassis

While the PXIS-2508/2558T is an ultra-portable testing system, it is recommended that you transport or carry the chassis using the handles. The handles are designed to carry the weight of the chassis for superior portability and balance.

Handling Cables

Treat all cables with care. Do not over extend any cable to prevent internal breaking. All cables and plugs must be handled or connected properly.

Cleaning the Exterior

Make sure that you turn the system off before cleaning the chassis exterior. Wipe the exterior with a clean cloth starting from areas that easily accumulate dust or dirt such as the area in and around the chassis and power supply air inlet apertures.

Power Requirements

Make sure that the power cord is in good condition before plugging it into the system. You also need to check the reliability of the power source. The PXIS-2508/2558T power supply is capable of handling 100 V to 240 V AC within the 50 Hz to 60 Hz range. Do not connect the PXIS-2508/2558T on an already overloaded circuit.

Important Safety Instructions

Read and follow all instructions marked on the product and in the documentation before operating the system. Retain all safety and operating instructions for future use.

- ▶ Read these safety instructions carefully.
- ▶ Keep this user's manual for future reference.
- ▶ The equipment should be operated in an ambient temperature between 0°C to 50°C.
- ▶ The equipment should be operated only from the type of power source indicated on the rating label. Make sure the voltage of the power source is correct when connecting the equipment to the power outlet.
- ▶ If the user's equipment has a voltage selector switch, make sure that the switch is set to the proper position for the area. The voltage selector switch is set at the factory to the correct voltage.
- ▶ For pluggable equipment, ensure they are installed near a socket-outlet that is easily accessible.
- ▶ Secure the power cord to prevent unnecessary accidents. Do not place anything over the power cord.
- ▶ If the equipment will not be in use for long periods of time, disconnect the equipment from the power outlet to avoid being damaged by transient over voltage.
- ▶ All cautions and warnings on the equipment must be noted.
- ▶ Keep this equipment away from humidity.
- ▶ Do not use this equipment near water or a heat source.
- ▶ Place this equipment on a stable surface when installing to prevent injury.
- ▶ Never pour any liquid into the product to prevent fire or electrical shock.

- ▶ Openings in the chassis are provided for ventilation. Do not block or cover these openings. Make sure there is adequate space around the system for ventilation when setting up the work area. Never insert objects of any kind into the ventilation holes.
- ▶ To avoid electrical shock, always unplug all power and modem cables from wall outlets before removing the system covers.
- ▶ The equipment must be serviced by authorized technicians when:
 - ▷ The power cord or plug is damaged.
 - ▷ Liquid has penetrated the equipment.
 - ▷ It has been exposed to moisture.
 - ▷ It is not functioning or does not function according to the user's manual.
 - ▷ It has been dropped and damaged.
 - ▷ It has an obvious sign of breakage.
- ▶ Never attempt to fix the equipment. For safety reasons, the equipment should only be serviced by qualified personnel.

Warranty Policy

Thank you for choosing ADLINK. To understand your rights and enjoy all the after-sales services we offer, please read the following carefully.

1. Before using ADLINK's products please read the user manual and follow the instructions exactly. When sending in damaged products for repair, please attach an RMA application form which can be downloaded from:
<http://rma.adlinktech.com/policy/RMA.doc>
2. All ADLINK products come with a limited two-year warranty, one year for products bought in China:
 - ▷ The warranty period starts on the day the product is shipped from ADLINK's factory.
 - ▷ Peripherals and third-party products not manufactured by ADLINK will be covered by the original manufacturers' warranty.
 - ▷ For products containing storage devices (hard drives, flash cards, etc.), please back up your data before sending them for repair. ADLINK is not responsible for any loss of data.
 - ▷ Please ensure the use of properly licensed software with our systems. ADLINK does not condone the use of pirated software and will not service systems using such software. ADLINK will not be held legally responsible for products shipped with unlicensed software installed by the user.
 - ▷ For general repairs, please do not include peripheral accessories. If peripherals need to be included, be certain to specify which items you sent on the RMA Request & Confirmation Form. ADLINK is not responsible for items not listed on the RMA Request & Confirmation Form.

3. Our repair service is not covered by ADLINK's guarantee in the following situations:
 - ▷ Damage caused by not following instructions in the User's Manual.
 - ▷ Damage caused by carelessness on the user's part during product transportation.
 - ▷ Damage caused by fire, earthquakes, floods, lightening, pollution, other acts of God, and/or incorrect usage of voltage transformers.
 - ▷ Damage caused by unsuitable storage environments (i.e. high temperatures, high humidity, or volatile chemicals).
 - ▷ Damage caused by leakage of battery fluid during or after change of batteries by customer/user.
 - ▷ Damage from improper repair by unauthorized ADLINK technicians.
 - ▷ Products with altered and/or damaged serial numbers are not entitled to our service.
 - ▷ This warranty is not transferable or extendible.
 - ▷ Other categories not protected under our warranty.
4. Customers are responsible for shipping costs to transport damaged products to our company or sales office.
5. To ensure the speed and quality of product repair, please download an RMA application form from our company website: <http://rma.adlinktech.com/policy>. Damaged products with attached RMA forms receive priority.

If you have any further questions, please email our FAE staff: service@adlinktech.com.